

SERRE DE JARDIN

Annexe pour:

- SERRE 5 x 7,50 mètres

Ø40

Fabrication Ardéchoise

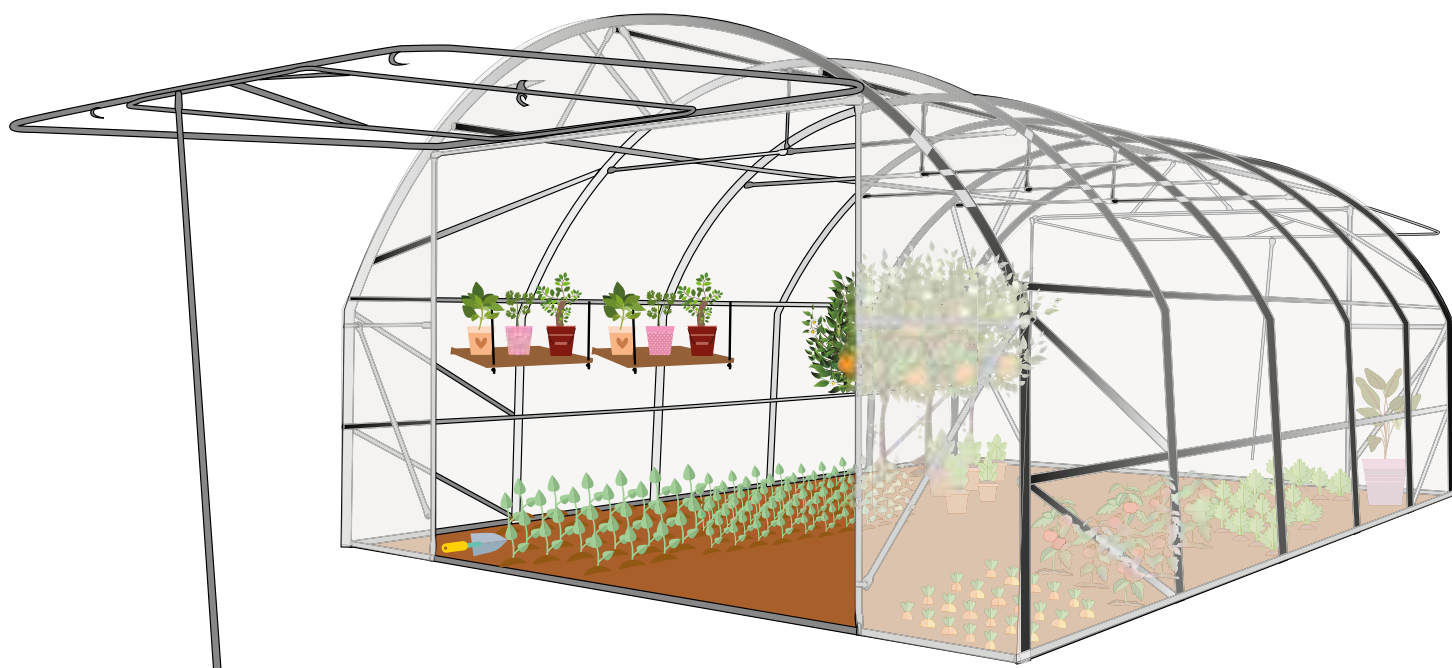

RECEPTION DE VOTRE SERRE

Le colis de votre serre comporte 10 cartons et la visserie (incluse dans un carton)

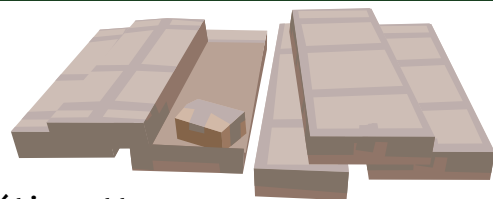

Chaque carton arrive avec une étiquette

Date de votre carton

00/00
00

CARTON **23**

Réf	Diam	Qté	Valid
C32	Ø32	3	•

Détaille des pièces

Numéro de carton

23

Responsable

Resp :

POIDS :

Référence de votre carton

00/00

CARTON **22**

Numéro de carton

Réf	Diam	Qté	Valid

Détaille des pièces

Réf	Diam	Qté	Valid

Responsable

Resp :

POIDS :

Carton avec la bâche :

Référence de votre carton

(xxx)

Dimension de la bâche

Bâche : 00m x 00m

Numéro de carton

22

Responsable

Resp :

⚠ Il faut noter le numéro d'identification manuscrit (lettres/chiffres) qui se trouve à l'intérieur du carton de la visserie. En cas de manque il vous sera demandé par le service après vente.

⚠ Vous avez 2 mois pour signaler toutes pièces manquantes au SAV

NOMENCLATURE

Carton n° 50

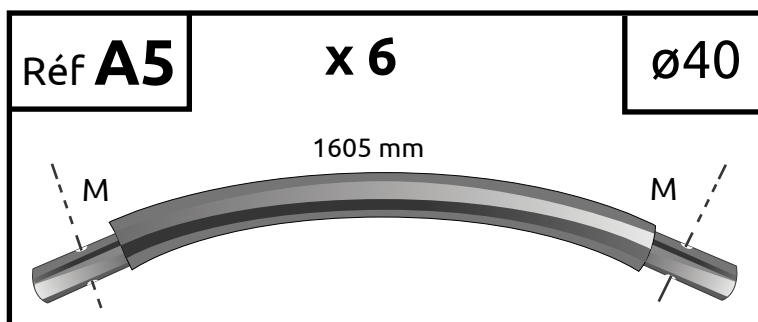

M = Mâle
F = Femelle
EC = Ecrasé + trou

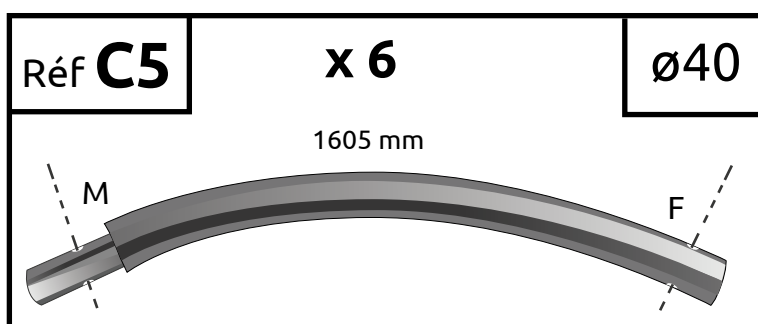

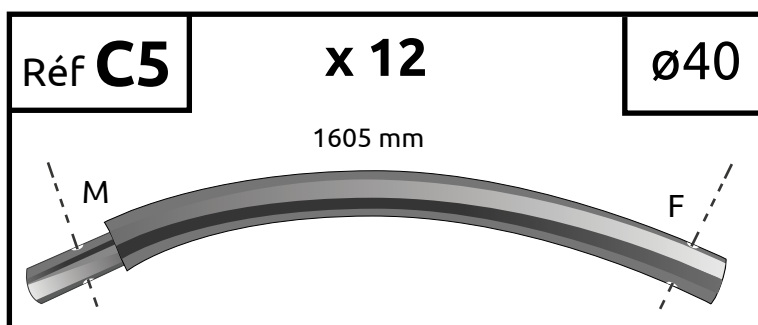

La mesure des pièces est indicative et peut varier de quelques mm

Carton n° 51



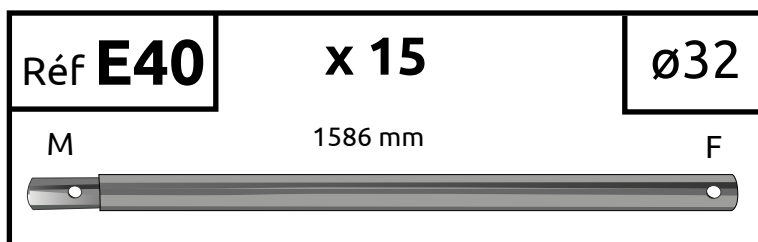

Carton n° 52





Réf OT	x 4	ø32
EC	1570mm	EC
		

Réf P25	x 6	ø25
EC	355 mm	EC
		

Réf D40	x 2	ø32
F	1586 mm	F
		

Réf J32	x 2	ø32
M	1555mm	Main
		

Réf K32	x 2	ø32
F	1555mm	Main
		

Réf Z5	x 8	ø25
EC	1620 mm	EC
		

Réf KT	x 2	ø32
EC	1580 mm	F
		

Carton n° 55

Réf Q5	x 4	ø32
EC	840 mm	EC
		

Réf U5	x 8	ø25
EC	520 mm	EC
		

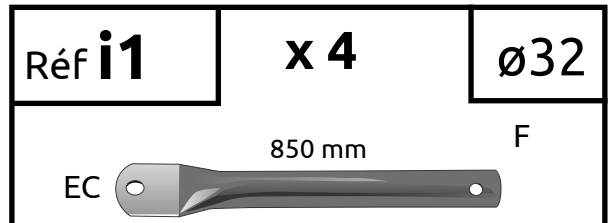
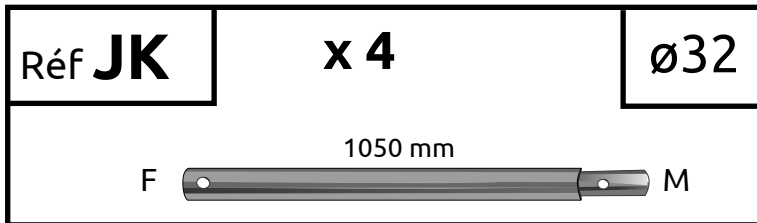
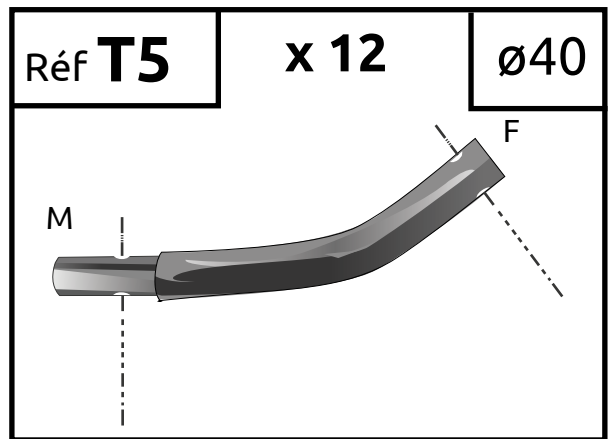
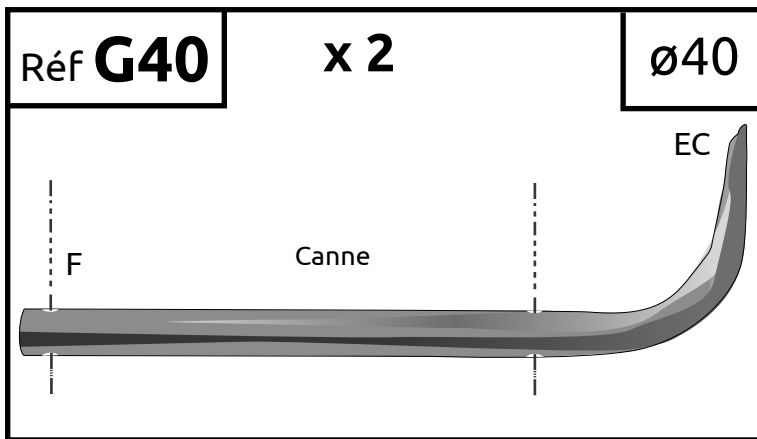

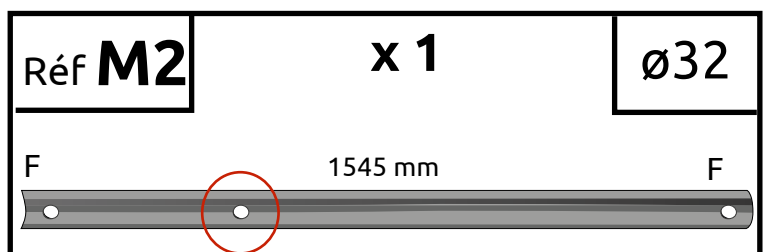
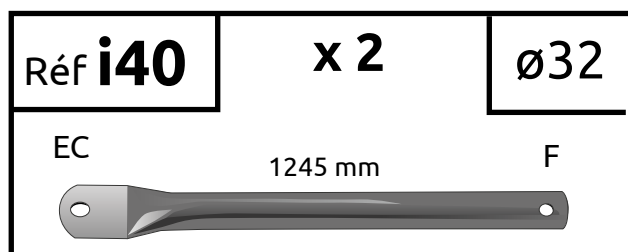
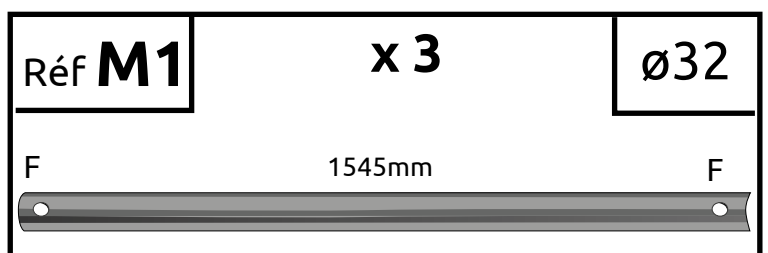
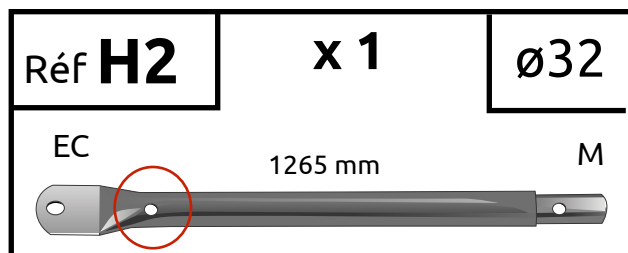
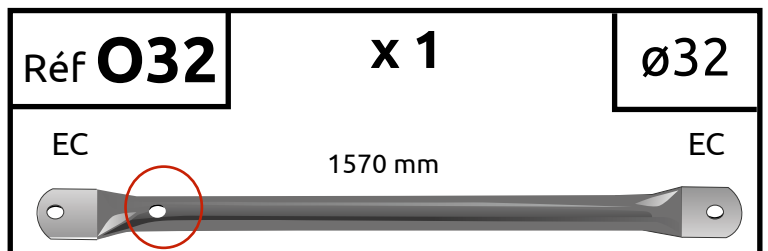
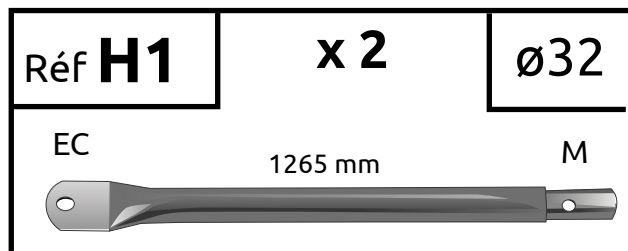

Carton n° 57 (x2)

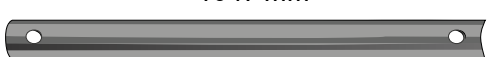

Réf N32	x 2	ø32
1047 mm		
F		F

Réf OF25	x 1	ø25
1525 mm		
EC		EC

Réf OP	x 1	ø32
1426 mm		
EC		EC

Réf P25	x 2	ø25
355 mm		
EC		EC

Réf S32	x 2	ø32
≈ 320 mm		
EC		EC

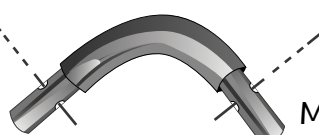
Réf L32	x 8	ø32
Coude 90°		
M		M

Réf RM	x 2	ø32
470 mm		
F		M

Réf CPB	x 2	ø32
855 mm		
F		F

Réf Y5	x 2	ø32
965 mm		
EC		EC

Réf E40	x 2	ø32
1588 mm		
M		F

Tube	x 1	ø32
1170 mm		
F		F

Réf E32	x 2	ø32
1272 mm		
M		F

Réf D32	x 1	ø32
1272 mm		
F		F

Carton n° 42

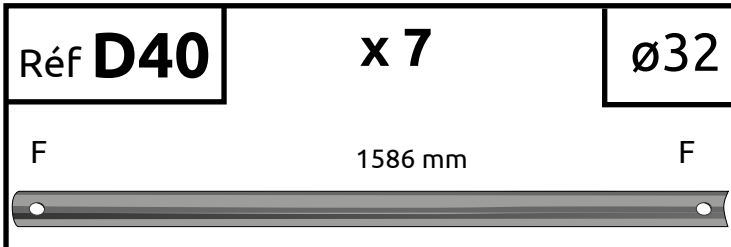
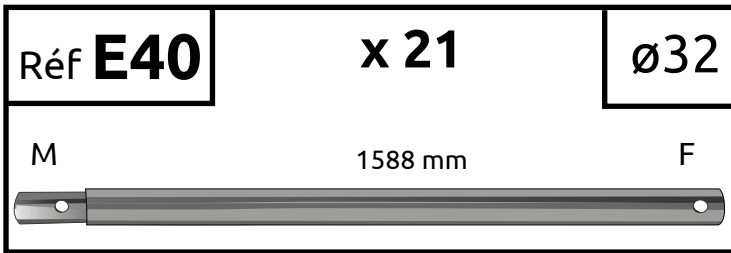

Carton n° 45

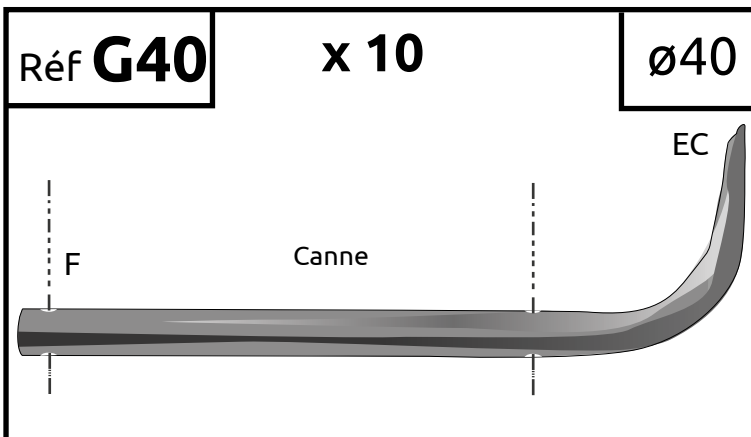

Sur le carton

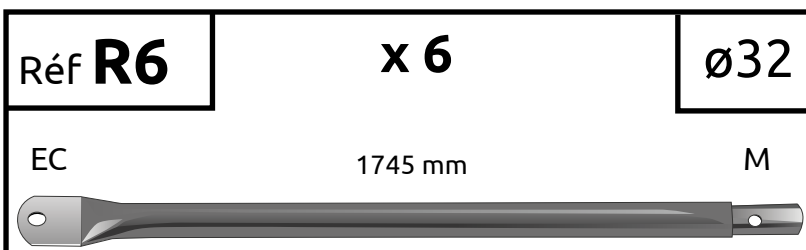
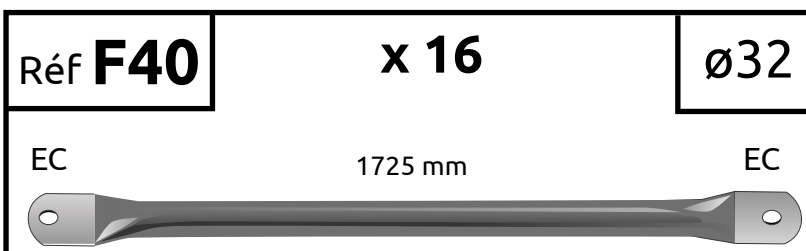

Carton n° 87

Bâche dôme 12,50 x 8,50

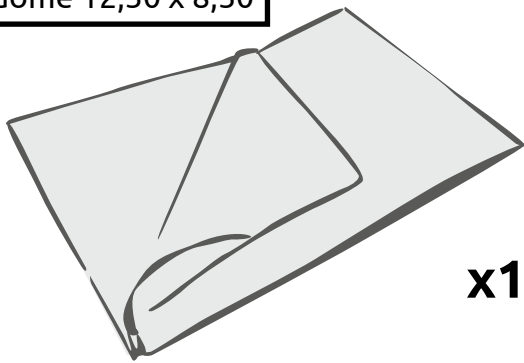

x1

Carton n° 59

Bâche pignon 7 x 8

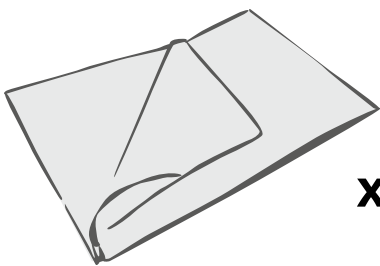

x1

Bouchon



x 24

Brides ø 32



x 42

Brides ø 40



x 44

Charnières noir ø 32
+ rondelles dorées



x6

Charnières ø 32
+ rondelles dorées



x 8

U Porte ø 32
SANS TROU



x 8

U Porte ø 32
AVEC TROU



x 2

Clips ø 40



x 50

Clips ø 32



x 150

Boulon ø8 x 30

x 120



Boulon ø6 x 80

x 56

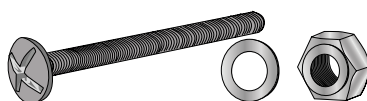

Boulon ø6 x 50

x 76

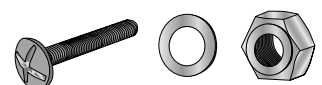

VUE ÉCLATÉE DE VOTRE SERRE

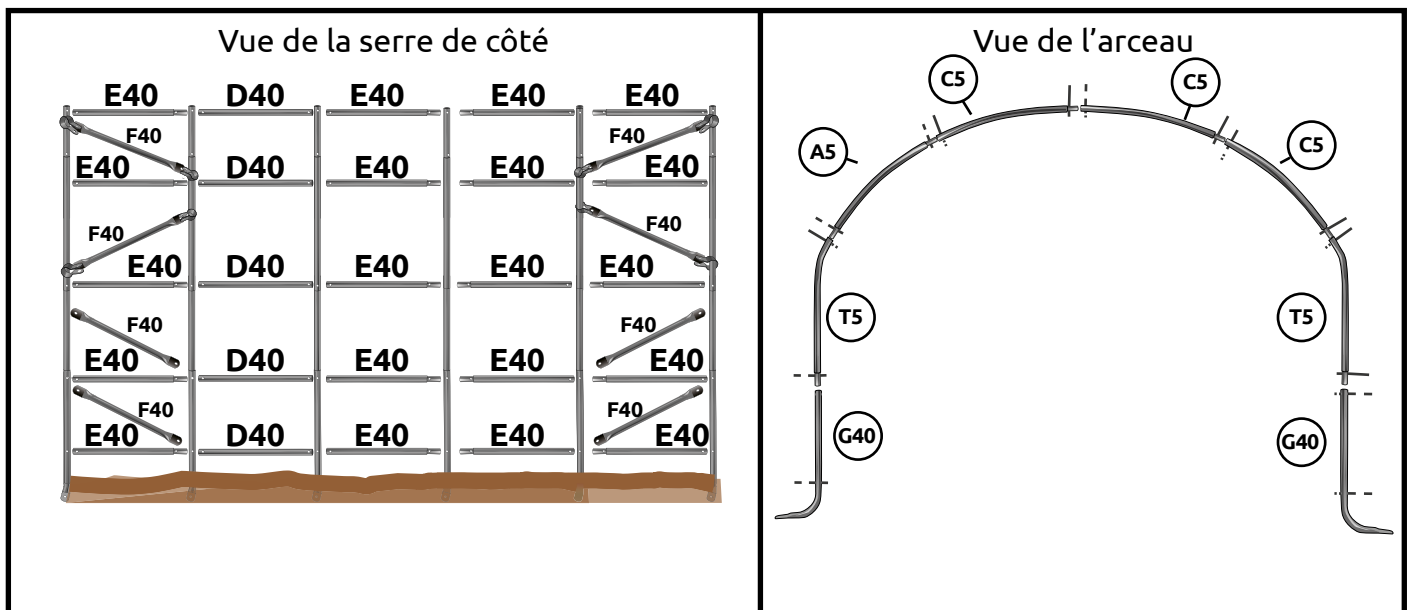
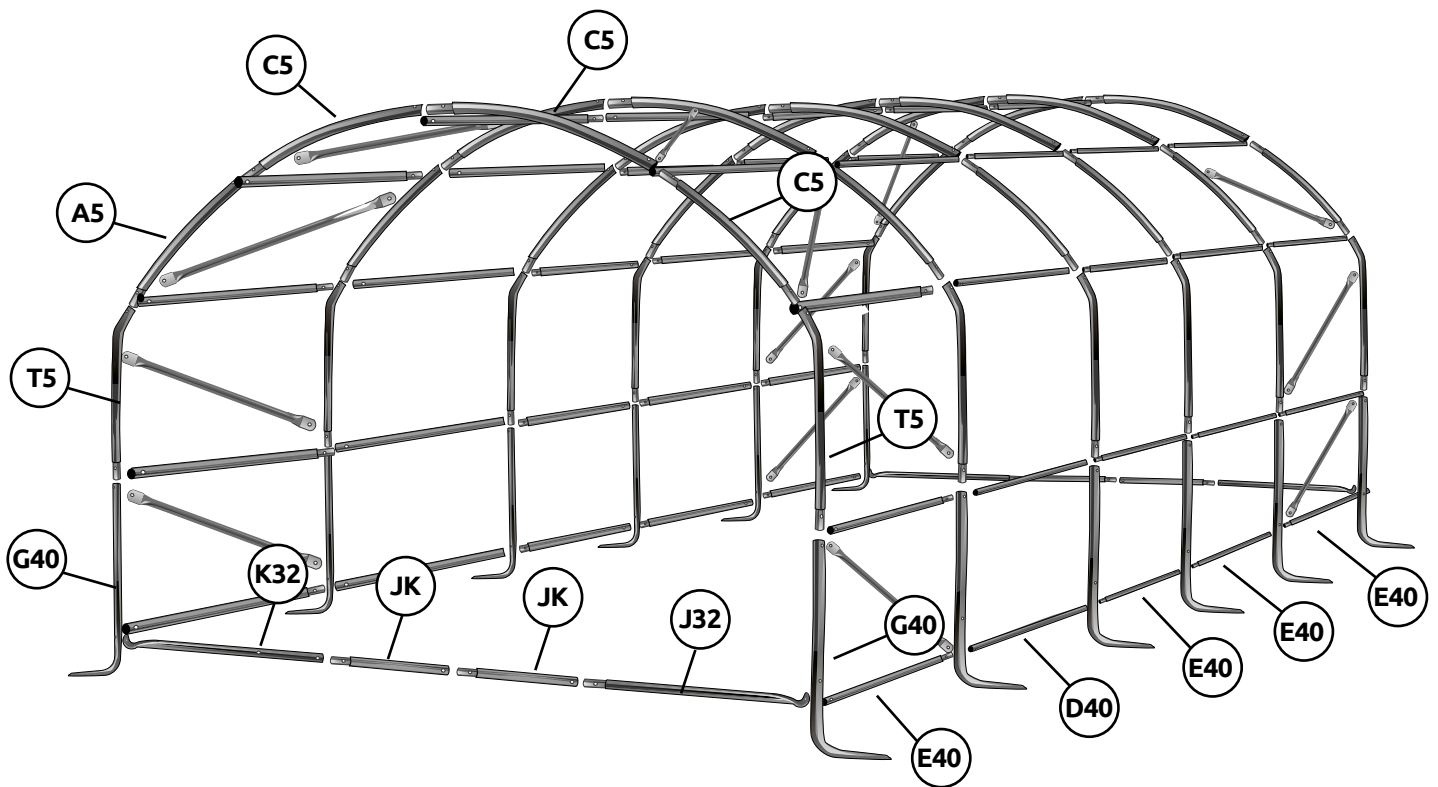

DÉCOUPE DE LA BÂCHE



Déplier votre bâche des pignons de 8 m x 7 m et faites vos découpes



Ne pas déplier votre bâche lorsque la température extérieure est inférieure à 15°C ressentie (beau temps)



Montez votre bâche au soleil de manière à ce qu'elle soit plus facile à tendre !

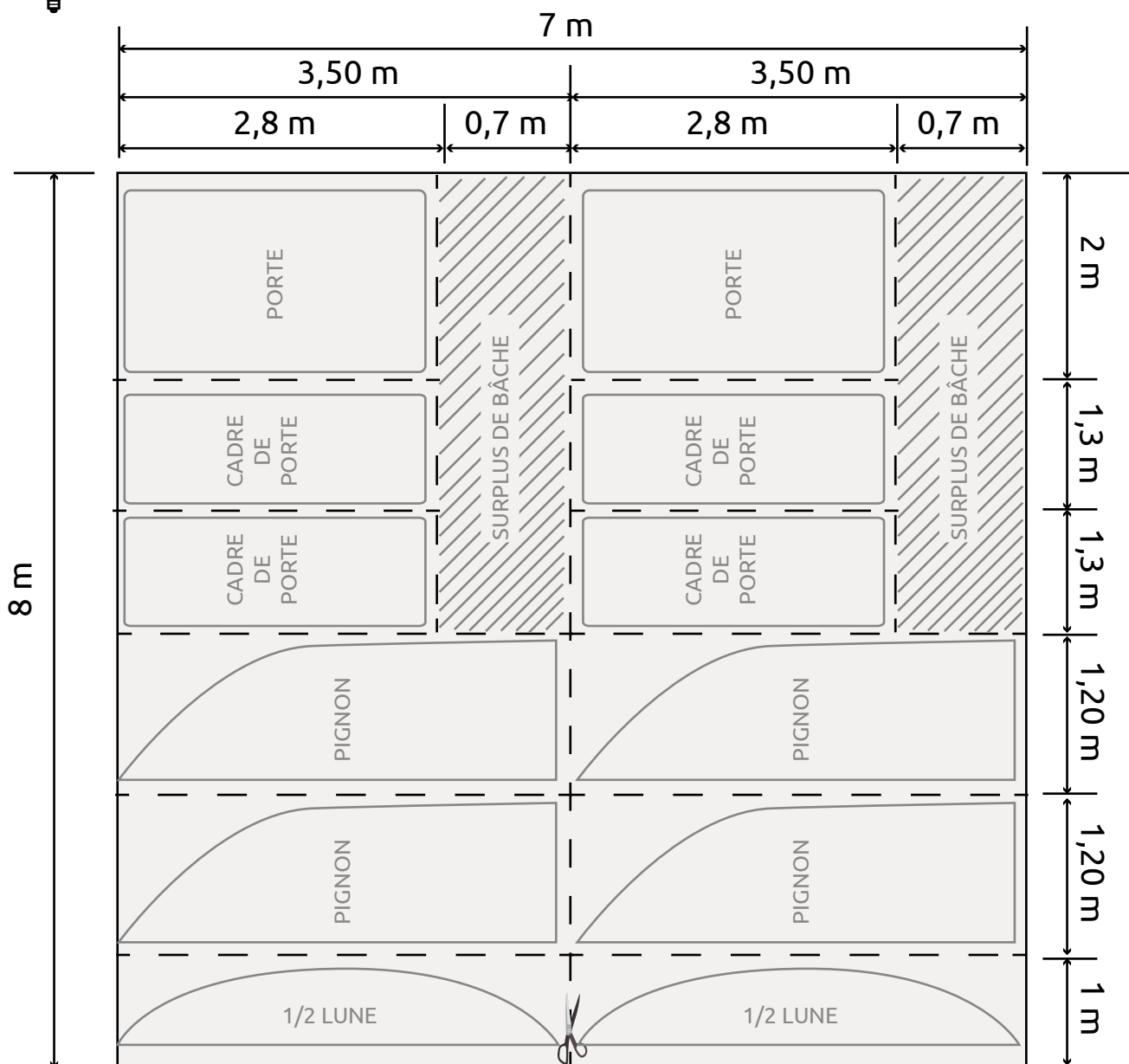

Pour monter votre bâche nous vous conseillons de regarder notre tuto C2M, que vous avez reçu par mail avec votre notice ou sur internet sur le lien : <https://www.youtube.com/watch?v=1PFESTq750A>